





Mountainbike Leitsystem

offizielle Routenschilder

Schildertyp	Mustertafel	Preis pro Stk.
Ausgangsschild 200x260x3 + 1 Lasche		23,70 € excl. MwSt.
Richtungsschild 200x200x3 + 1 Lasche		22,40 € excl. MwSt.
Richtungspfeil groß für Ausgangs- und Richtungsschild wird vor Ort aufgeklebt		1,30 € excl. MwSt.
Reduziertes Richtungsschild 120x120x3 + 1 Lasche		16,70 € excl. MwSt.
Richtungspfeil klein für reduziertes Richtungsschild wird vor Ort aufgeklebt		1,30 € excl. MwSt.



HERR STEINDL GMBH

6290 Mayrhofen i.Z.
Kreuzlau 390b

T. +43.5285.650650
F. +43.5285.650650-25
M. info@herr-steindl.at

wirliebenherausforderungen.at

HERR
STEINDL

WEGWEISENDE
WERBETECHNIK

Gültig ab 01.01.2022

Mountainbike Leitsystem

offizielle Routenschilder

Schildertyp	Mustertafel	Preis pro Stk.
<p>Verhaltensregeln 200x420x3 + 2 Laschen</p>		<p>36,90 € excl. Mwst.</p>
<p>Richtungsschild Routenname mit separater Zielbeschriftung 200x260x3 + 1 Lasche</p>		<p>23,70 € excl. Mwst.</p>
<p>Richtungsschild 2 Routen 200x420x3 + 2 Laschen</p>		<p>36,90 € excl. Mwst.</p>



HERR STEINDL GMBH

6290 Mayrhofen i.Z.
Kreuzlau 390b

T. +43.5285.650650
F. +43.5285.650650-25
M. info@herr-steindl.at

wirlebenherausforderungen.at

Gültig ab 01.01.2022

Mountainbike Leitsystem

offizielle Routenschilder

Schildertyp	Mustertafel	Preis pro Stk.
<p>Richtungsschild 2 Routen 200x260x3 + 1 Lasche</p>		<p>23,70 € excl. Mwst.</p>
<p>Richtungsschild 3 Routen 200x420x3 + 2 Laschen</p>		<p>36,90 € excl. Mwst.</p>
<p>MTB Route Ende 200x200x3 + 1 Lasche</p>		<p>22,40 € excl. Mwst.</p>
<p>Schiebestrecke 200x200x3 + 1 Lasche</p>		<p>22,40 € excl. Mwst.</p>



HERR STEINDL GMBH

6290 Mayrhofen i.Z.
Kreuzlau 390b



T. +43.5285.650650
F. +43.5285.650650-25
M. info@herr-steindl.at

wirliebenherausforderungen.at

Gültig ab 01.01.2022

Mountainbike Leitsystem

offizielle Routenschilder

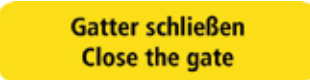
Schildertyp	Mustertafel	Preis pro Stk.
<p>Gesperrt 200x260x3 + 1 Lasche</p>		<p>23,70 € excl. MwSt.</p>
<p>Kreuzung 200x260x3 + 1 Lasche</p>		<p>23,70 € excl. MwSt.</p>
<p>Ausgenommen Radfahren 470x230x3 + 1 Lasche</p>		<p>36,95 € excl. MwSt.</p>
<p>Gatter Schliessen 200x50x3 + 1 Lasche</p>	 <p>alternative Beschriftungen möglich</p>	<p>15,25 € excl. MwSt.</p>

Datenübernahme pro Route: 45,- Euro excl. MwSt.



HERR STEINDL GMBH

6290 Mayrhofen i.Z.
Kreuzlau 390b

T. +43.5285.650650
F. +43.5285.650650-25
M. info@herr-steindl.at

wirliebenherausforderungen.at













HERR
STEINDL

WEGWEISENDE
WERBETECHNIK

Gültig ab 01.01.2022

Singletrail Leitsystem

offizielle Routenschilder

Schildertyp	Mustertafel	Preis pro Stk.
Ausgangsschild 200x260x3 + 1 Lasche	 <p>BIKEGEBIET/ODER TVB + LOGO</p> <p>← </p> <p>000 Routenname</p> <p>Zelfinish: Mustertext Länge/Length: 0,0 km Höhenmeter Auffahrt/Altitude difference uphill: 0 m Höhenmeter Abfahrt/Altitude difference downhill: 0 m Schwierigkeit/Difficulty: leicht/easy</p> <p>  </p>	23,70 € excl. MwSt.
Richtungsschild 200x200x3 + 1 Lasche	 <p>BIKEGEBIET/ODER TVB + LOGO</p> <p>← </p> <p>000 Routenname</p> <p> </p>	22,40 € excl. MwSt.
Richtungspfeil groß für Ausgangs- und Richtungsschild wird vor Ort aufgeklebt		1,30 € excl. MwSt.
Verhaltensregeln 200x420x3 + 2 Laschen	 <p>BIKEGEBIET/ODER TVB + LOGO</p> <p>Single-Trail. Spezifische Bikeregeln.</p> <ul style="list-style-type: none"> • Achtung! Befahren auf eigene Gefahr, nur mit kontrollierter Geschwindigkeit und auf halbe Sicht. Steigzustand wird nicht kontrolliert! • Nehmen Rücksicht auf Wanderer, Weidevieh und Wild. Fahre nicht abseits des Steigs und schließe die Weidegatter. • Achse auf alpine Gefahren! • Wiederlasse keine Spuren! Abfäzungen und blockierte Harnsäcker beschädigen den Trail. • Notrufnummer: 140 oder 112 <p>Single-Trail. Rules for Bikers.</p> <ul style="list-style-type: none"> • No checks are made on the condition of the trail and bikers using the trail do so at their own risk. Riders must be in control at all times and have a clear line of sight. • Keep to the trail and always show consideration for walkers, livestock and game. Always close the gates. • Be alert at all times to the hazards of the mountain environment. • Leave no trace! Don't cut switchbacks. Blocked rear wheels damage the trail. • Emergency number: 140 or 112 <p> </p>	36,90 € excl. MwSt.



HERR STEINDL GMBH

6290 Mayrhofen i.Z.
Kreuzlau 390b

T. +43.5285.650650
F. +43.5285.650650-25
M. info@herr-steindl.at

wirliebenherausforderungen.at



HERR
STEINDL

WEGWEISENDE
WERBETECHNIK

Gültig ab 01.01.2022

Singletrail Leitsystem

offizielle Routenschilder

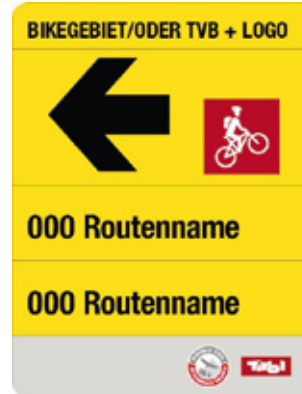
Schildertyp	Mustertafel	Preis pro Stk.
<p>Reduziertes Richtungsschild 120x120x3 + 1 Lasche</p>		<p>16,70 € excl. MwSt.</p>
<p>Richtungspfeil klein für reduziertes Richtungsschild wird vor Ort aufgeklebt</p>		<p>1,30 € excl. MwSt.</p>
<p>Richtungsschild 2 Trails 200x420x3 + 2 Laschen</p>		<p>36,90 € excl. MwSt.</p>
<p>Richtungsschild 2 Trails 200x260x3 + 1 Lasche</p>		<p>23,70 € excl. MwSt.</p>



HERR STEINDL GMBH

6290 Mayrhofen i.Z.
Kreuzlau 390b

T. +43.5285.650650
F. +43.5285.650650-25
M. info@herr-steindl.at

wirliebenherausforderungen.at



HERR
STEINDL

WEGWEISENDE
WERBETECHNIK

Gültig ab 01.01.2022

Singletrail Leitsystem

offizielle Routenschilder

Schildertyp	Mustertafel	Preis pro Stk.
Schiebestrecke 200x200x3 + 1 Lasche		22,40 € excl. Mwst.
Wander / MTB Weg 200x200x3 + 1 Lasche		22,40 € excl. Mwst.
Weg nur für Biker 200x200x3 + 1 Lasche		22,40 € excl. Mwst.
Weg nur für Wanderer 200x200x3 + 1 Lasche		22,40 € excl. Mwst.
Trail Ende 200x200x3 + 1 Lasche		22,40 € excl. Mwst.



HERR STEINDL GMBH

6290 Mayrhofen i.Z.
Kreuzlau 390b

T. +43.5285.650650
F. +43.5285.650650-25
M. info@herr-steindl.at

wirliebenherausforderungen.at

Gültig ab 01.01.2022

Singletrail Leitsystem

offizielle Routenschilder

Schildertyp	Mustertafel	Preis pro Stk.
<p>Rettungspunkte Ausgangstafel 200x420x3 + 2 Laschen</p>		<p>36,90 € excl. Mwst.</p>
<p>Gesperrt 200x260x3 + 1 Lasche</p>		<p>23,70 € excl. Mwst.</p>
<p>Kreuzung 200x260x3 + 1 Lasche</p>		<p>23,70 € excl. Mwst.</p>



**HERR
STEINDL**

WEGWEISENDE
WERBETECHNIK

Gültig ab 01.01.2022

HERR STEINDL GMBH

6290 Mayrhofen i.Z.
Kreuzlau 390b

T. +43.5285.650650
F. +43.5285.650650-25
M. info@herr-steindl.at

wirlebenherausforderungen.at

Singletrail Leitsystem

offizielle Routenschilder

Schildertyp	Mustertafel	Preis pro Stk.
Langsam 200x260x3 + 1 Lasche		23,70 € excl. Mwst.
Achtung 200x260x3 + 1 Lasche		23,70 € excl. Mwst.
Bergauf Biken verboten 200x260x3 + 1 Lasche		23,70 € excl. Mwst.
Gatter Schliessen 200x50x3 + 1 Lasche	 alternative Beschriftungen möglich	15,25 € excl. Mwst.

Datenübernahme pro Route: 45,- Euro excl. Mwst.



HERR STEINDL GMBH

6290 Mayrhofen i.Z.
Kreuzlau 390b

T. +43.5285.650650
F. +43.5285.650650-25
M. info@herr-steindl.at

wirliebenherausforderungen.at

HERR
STEINDL

WEGWEISENDE
WERBETECHNIK

Gültig ab 01.01.2022

Bike Leitsysteme

Zubehör und Montage

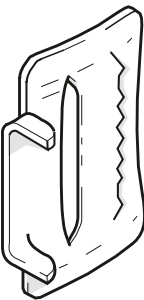
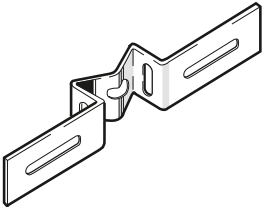
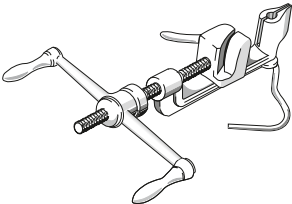
Schildertyp	Mustertafel	Preis pro Stk.
Spannschlaufe SSA für Stahlband 19mm breit Spanngerät erforderlich		1,15 € excl. MwSt.
Stahlband 19mm VE: 50 Laufmeter		112,- € excl. MwSt.
Lasche geeignet zur Anbringung an Rohrpfeosten und Masten aller Art		inkludiert bei jedem Schild
Spann- und Abschneidegerät		105,- € excl. MwSt.



HERR STEINDL GMBH

6290 Mayrhofen i.Z.
Kreuzlau 390b

T. +43.5285.650650
F. +43.5285.650650-25
M. info@herr-steindl.at

wirliedenherausforderungen.at

HERR
STEINDL

WEGWEISENDE
WERBETECHNIK

Gültig ab 01.01.2022